

# **IN-SITU MONITORING AND CONTROL OF INDUCTION WELDING IN THERMOPLASTIC COMPOSITES USING HIGH DEFINITION FIBER OPTIC SENSORS**

Nur Aida Abdul Rahim<sup>1</sup>, Jaspreet Pandher<sup>2</sup>, Nicholas Coppola<sup>2</sup>, Vivek Penumetsa<sup>2</sup>, Dr. Michel van Tooren<sup>2</sup>

<sup>1</sup>Luna Innovations Inc.  
Blacksburg, VA 24060

<sup>2</sup>SmartState Center for Multifunctional Materials and Structures  
University of South Carolina  
Columbia SC 29201

## **ABSTRACT**

This paper presents a novel method for providing temperature feedback to the control system of an induction welder during the joining of thermoplastic composite components. Thermoplastic composites are attractive due to their ability to be re-heated and melted repeatedly without degrading the strength of the materials. This enables joining components via fusion bonding or welding, bypassing mechanical fasteners or adhesive bonding completely. In order to ensure a successful joint, the relevant process parameters need to be dialed in and controlled, for specific levels and durations. Induction welding has the advantage of applying a very localized heat, minimizing geometrical distortion of the parts being joined. For the induction welding processes, current and pressure are controlled in an effort to achieve the appropriate temperature at the weld surface with sufficient force to join the two components. Thermocouples are the typical sensors used for temperature measurements, but their size prevents them from being accepted as an inclusion in the final part. As a viable alternative, high definition fiber optic sensing (HD-FOS) is explored as a method for providing a temperature measurement every 1.3 mm along the joint. The small form factor of the sensor lends itself to permanent embedding within the final part. In this work, a high-definition fiber optic sensor is used to provide spatially dense temperature measurements within an induction weld. A control scheme is set up to use the sensor's measurements as feedback to the controller and to adjust the settings accordingly. This functionality is demonstrated in a dynamic thermoplastic weld setup where the sensor is sandwiched in a lap shear joint configuration. The strength of this weld is evaluated after manufacture and correlated to in-situ temperature measurements. It is shown that HD-FOS could significantly benefit the quality of the final composite part by providing spatially resolved in-situ feedback to the control system to insure uniform temperature profiles at the weld zone and proper processing conditions for each production part.

## **1. INTRODUCTION**

Thermoplastic composites are attractive for aerospace structural applications due to the ability to join them via fusion bonding [1-2]. This is one of the key advantages of thermoplastic polymers compared to thermosets or other dissimilar material joints. In fusion-bonding, the polymer on the bond surfaces of the component are heated to melt, and these surfaces are pressed together,

resulting in polymer solidification and consolidation. Fusion bonding eliminates the need for mechanical fasteners and adhesive bonding altogether, thus reducing part count, assembly time, and assembly cost, as well as eliminating potential cyclic fatigue failure points. Of the multiple fusion bonding techniques available, induction welding is of major interest because it is a volumetric heating method and therefore does not require all heat to flow through a contact surface. The technique involves moving an induction coil along the weld line. This induces eddy currents in the inherently conductive carbon fiber (CF) laminate. Heat is generated, which melts the thermoplastic. In addition, the heating can be steered by tailoring the laminates to be welded.

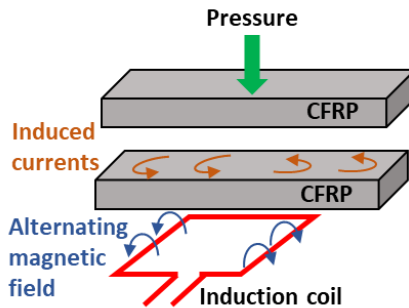


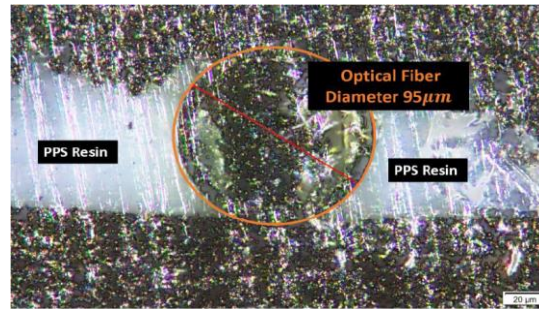
Figure 1: Schematic of induction welding process.

### 1.1 Induction Welding Process Parameters

When setting up an induction welding process, the parameters used to control the induced current must be set within the process window at the weld zone. The three primary physics parameters used for controlling the process at the weld interface are current (temperature), pressure, and time (duration) at the set temperature and pressure application [3-5]. This work focuses on temperature as it is the more difficult physical parameter to monitor and control in a production level environment. This is because the required temperatures for welding materials such as CF/PEKK (carbon fiber reinforced poly-ether-ketone-ketone) are high (approximately 400°C) and melting should be limited to the weld zone to prevent geometrical distortion. Additionally, the weld zone cannot be observed from outside the joint and in-situ sensors may compromise part quality once joining is complete.

### 1.2 Distributed Fiber Optic Sensing

Thermocouples are the typical sensors of choice for monitoring temperature within the weld zone, but their size prevents them from being accepted as an inclusion in the final part. As an alternative, high definition fiber optic sensing (HD-FOS) is explored as a method for providing a spatially resolved temperature measurement every 1.3mm in the weld line. The small form factor of the sensor used here (155 microns in diameter) lends itself to minimal invasiveness within the final part, easing compliance to structural and production requirements. Additionally, its non-conductiveness and immunity to radio-frequency interference (RFI) and electromagnetic interference (EMI) add to its attractiveness in this application. The accuracy and survivability of these sensors had been previously described up to up to 550°C [6]. It has also been employed to measure the temperature profile within a composite laminate during the resin curing process in order to qualify various heater pad designs [7]. In a previous thermoplastic induction welding application, polyphenylene sulfide (PPS)-coated optical fiber was integrated into the induction weld, as shown in Figure 2 [8].



**Figure 2: Microscopy of PPS-coated fiber integrated into the weld line.**

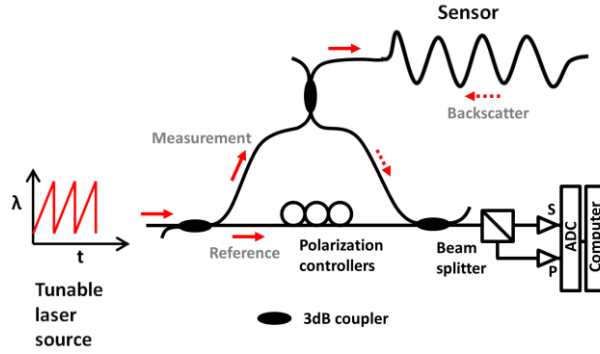
In this work, HD-FOS sensors are embedded in a weld line to provide in-situ temperature measurements. The data is streamed through TCP/IP into a separate computer. A closed loop control scheme is set up on this computer to monitor the time at temperature along the entire weld line. Once a set temperature is reached, the operator of the induction welder is prompted to adjust the location of the induction coils, keeping the weld interface within the desired processing temperature/time window. This assures that target temperatures are achieved at and outside of the weld zone. This functionality is demonstrated in a dynamic induction welding setup where the sensor is sandwiched in a lap shear joint configuration for typical CF/PEKK laminates. The mechanical properties of this weld are evaluated after manufacturing and correlated to in-situ temperature measurements.

## **2. METHODOLOGY**

### **2.1 Fiber Sensing Technique**

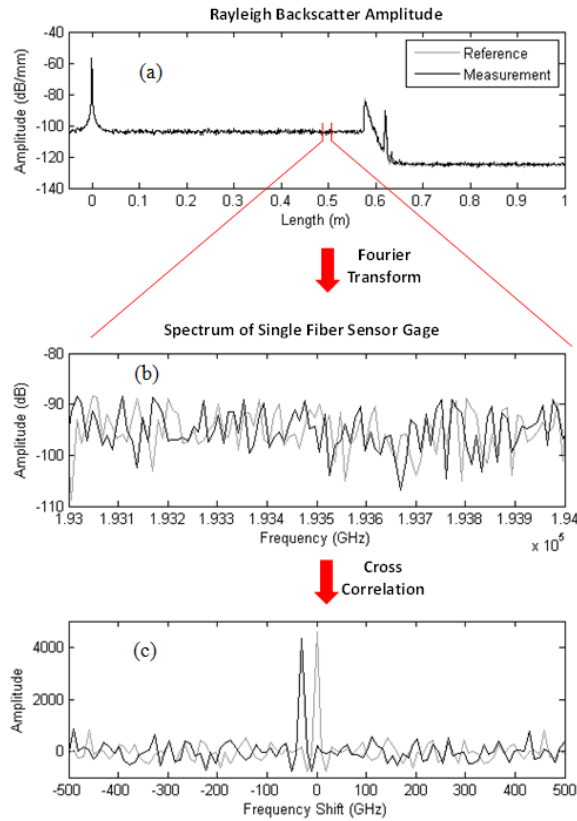
Temperature measurements were achieved by measuring the low amplitude signal of reflected light referred to as Rayleigh backscatter from an optical fiber sensor. These small amplitude reflections are an inherent phenomenon in fiber as a result of refractive index fluctuations naturally formed during the fiber's manufacturing process. The Rayleigh backscatter is a spatially random but static signal, making the scatter pattern unique for every individual fiber. Luna's interrogators utilize this scatter "fingerprint" to measure the difference in the fiber between its reference (or baseline) state and externally stimulated state. This difference is converted to temperature change, resulting in temperature measurements which are distributed continuously along the entire length of the fiber optic cable with very high spatial density [9-10].

Optical Frequency Domain Reflectometry (OFDR) is an interferometric method used to measure the phase and amplitude of reflected light [9-10]. A diagram of a basic OFDR network is shown in Figure 3 below. Light from a Tunable Laser Source (TLS) is swept linearly through a specified range of frequencies and split, through a coupler, between the reference and measurement arms of the interferometer. In the measurement path, light going through a coupler is reflected from the sensor and recombined with the light from the reference path. The Polarization Controller (PC) in the reference path helps ensure that light is split evenly between its two orthogonal polarization states as the combined signal passes through the Polarization Beam Splitter (PBS) and into the two detectors labeled S and P. A Fourier transform of the signal at the detectors results in the phase and amplitude of the signal as a function of length (or delay) along the sensor, i.e. the Rayleigh scatter fingerprint.



**Figure 3: Basic OFDR optical network.**

The spectral content of the sensor is compared between the measurement and reference states. Complex Fourier transform data is windowed around a desired measurement location (Figure 4 (a)). This window determines the gage length of the temperature measurement. An inverse Fourier transform of the windowed data gives the spectral content from a particular gage in the sensor (Figure 4 (b)), which is cross-correlated (Figure 4 (c)) with the spectrum from the same location of the sensor in a baseline state. Finally, the cross-correlated shift is converted to temperature change using an empirically determined calibration coefficient, or gage factor. This process is repeated along the length of the sensor, forming a distributed measurement.



**Figure 4: Frequency shift calculation from Rayleigh scatter measurement. (a) Rayleigh backscatter along optical path. (b) Spectrum of single sensor gage. (c) Cross-correlation of reference and measurement spectra.**

## 2.2 Induction Welding of Thermoplastic Composites

The composite material selected for this work is a unidirectional carbon fiber poly-ether-ketone (CF/PEKK) pre-preg from TenCate Advanced Composites (TC1320). The laminate was built up with a quasi-isotropic stacking sequence of [+45/0/-45/90/90/-45/0/+45]. Eight-ply CF/PEKK laminates, of dimension 610mm x 100mm, were consolidated in a hot platen press between two Upilex-S release films. Laminates were consolidated at a temperature of 340°C and a pressure of 10.3 Bar, conforming to specifications in the material data sheet [11]. The thickness of the consolidated laminates was 0.5 mm. The consolidated laminates were cut to lengths of 254 mm x 100 mm (10" x 4"), dried in an oven at 120°C for 4 hours, and degreased with acetone prior to welding. The consolidated laminates were placed in a lap shear configuration with a 2.54 cm (1") overlap for all tests.

An unjacketed polyimide coated fiber sensor (155  $\mu\text{m}$  outer diameter) was initially used for these tests. Due to strain coupling, a switch was made to using PTFE-jacketed polyimide coated fiber sensors (710  $\mu\text{m}$  initial outer diameter) instead. The fiber sensor was placed in the middle of the joint, between the two laminates (Figure 5), and the joint was vacuum bagged. The sensor was monitored using a Luna Innovations ODiSI 6104 HD-FOS measurement system during testing.

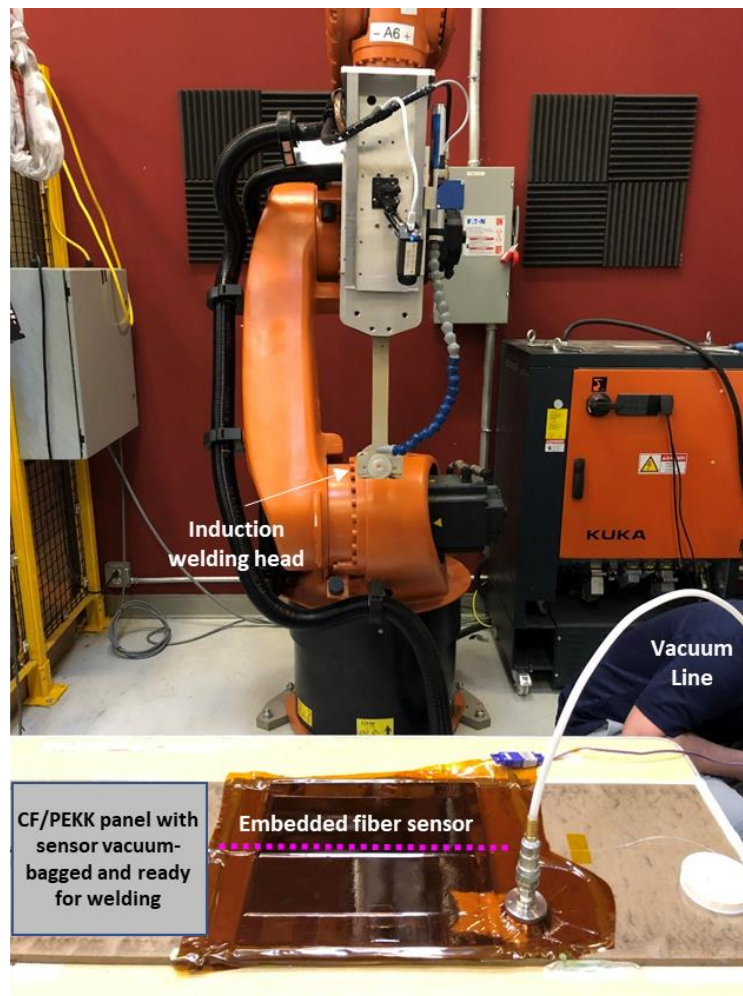


Figure 5: Induction welding setup.

The induction welder used for the tests consisted of an Ambrell EasyHeat Induction Heating System, Dimplex Thermal Solutions Chiller for induction coil liquid cooling, KvE proprietary induction welding end effector, and active air cooling on the top surface of the weld zone. The current was set to 500 A – 550 A. The current set point was fixed as the coil was moved along the weld zone. The location and speed of the welding arm was controlled through feedback from the embedded fiber sensor.

A zone-by-zone monitoring method was implemented where the embedded sensor was segmented into 10 zones of equal length and the mid-point of each zone was identified for monitoring. Measurement data from these points was sent out as a JSON-formatted TCP/IP data stream into a feedback control utility. The control utility allowed real-time monitoring of the temperature profile within the weld line. Once the welding process temperature had been reached at a particular zone, the control utility provided a notification to the welding operator to move on to the next zone. A schematic of this control system is shown in Figure 6.

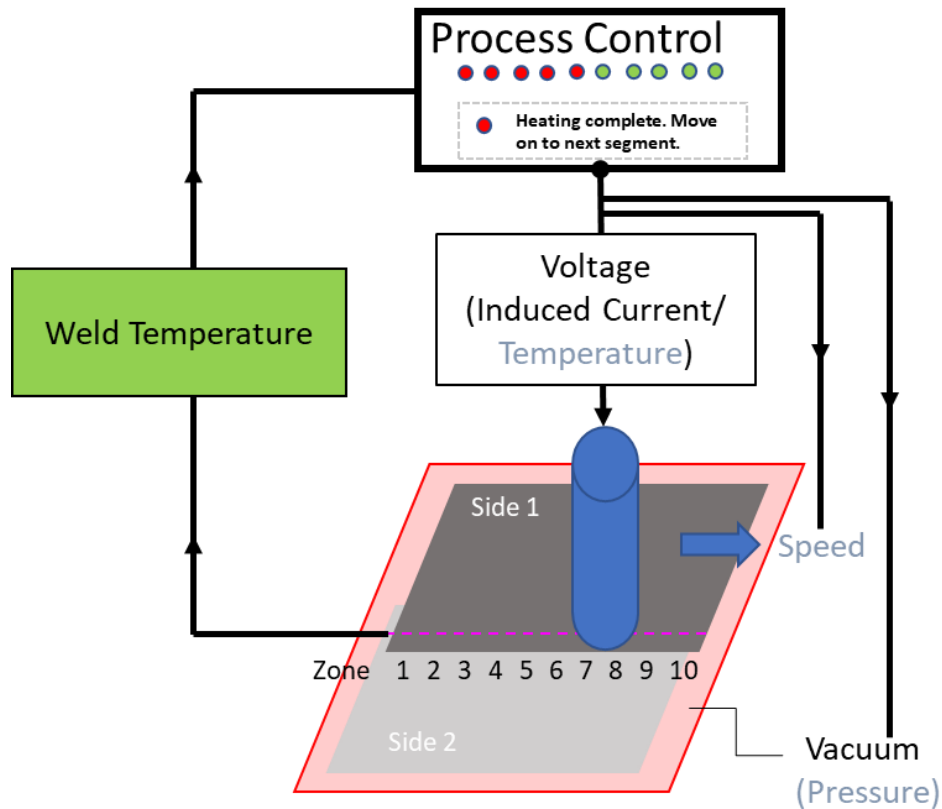


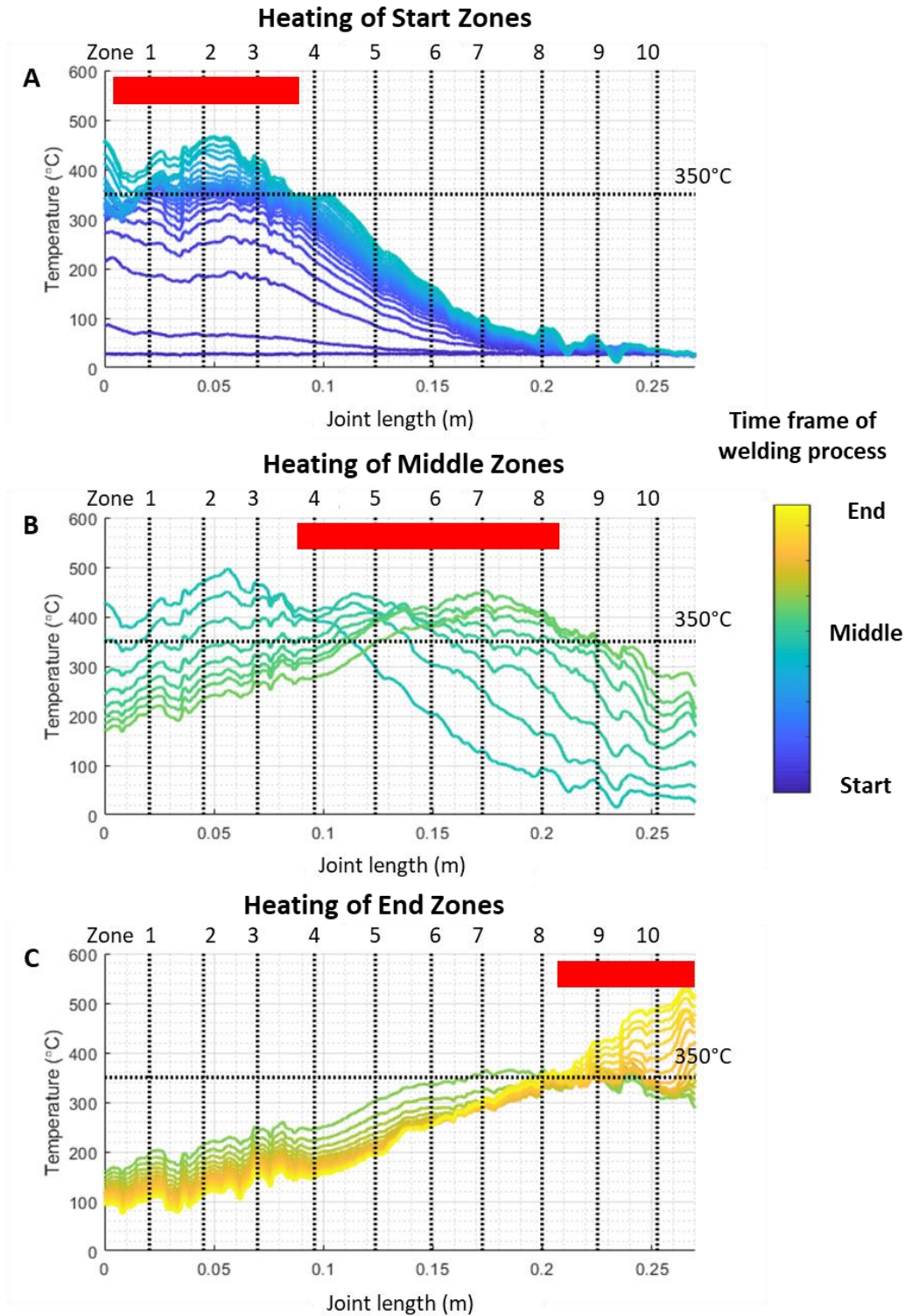
Figure 6: Schematic of feedback control loop.

### 3. RESULTS

A series of plates were welded together, using different sensor constructions, and induction coil travel rate combinations. These included a feedback-controlled weld using anunjacketed sensor, a feedback-controlled weld using a PTFE-jacketed sensor, and a constant travel rate weld using a PTFE-jacketed sensor. The associated results are discussed here.

#### 3.1 Unjacketed Sensor – Control Weld

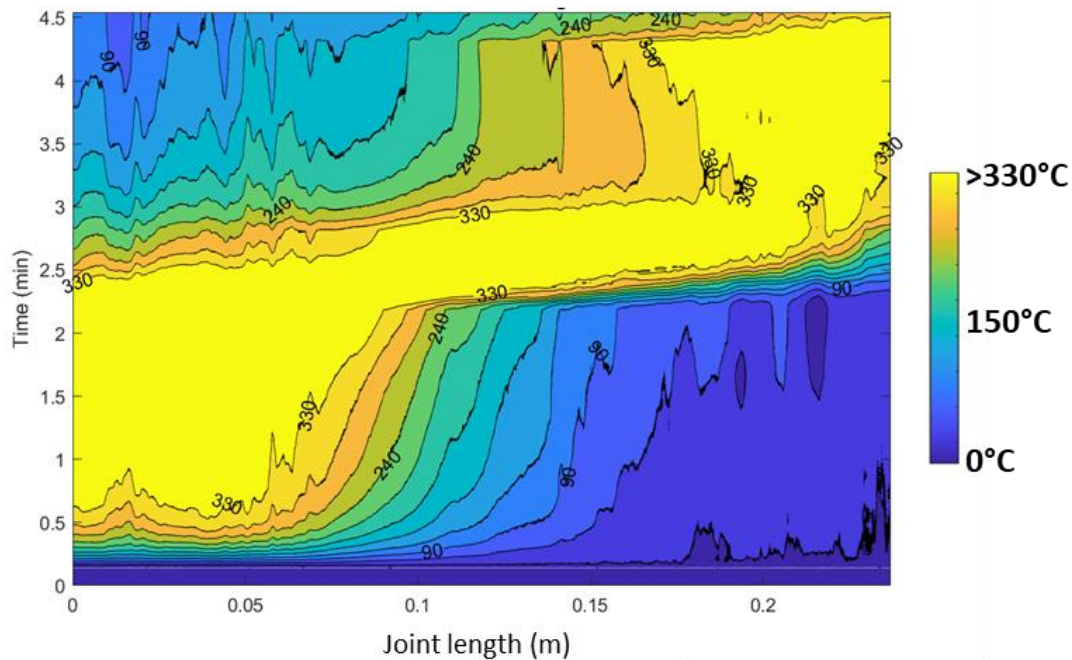
A 155  $\mu\text{m}$  diameter polyimide coated fiber optic sensor was laid within the shear joint. The current was set to 500 A. Temperature monitoring was initiated as the induction coil started in Zone 1. Figure 7 shows the spatial temperature profile along the entire sensor, with measurement traces plotted at 1.5 s intervals. When the induction coil is held in place over Zone 1, it can be seen that the heat induced extends over Zones 1 – 3 (Figure 7A). Once the temperature within these zones have collectively reached the set point, the induction coil moves rapidly through Zones 4 – 8 (Figure 7B). This is because the centrally-located zones reach the set point faster due to the physics of heat generation in bulk material far away from edge effects. Once within the end zone, the induction coil once again needs to be held in place for a longer time due to slower heating at the edge of the panel (Figure 7C).



**Figure 7: Spatial temperature profile along the entire unjacketed sensor, with measurement traces shown at 1.5 s intervals. A: Heating of start zones. B: Rapid travel through middle zones. C: Heating of end zones. Red bars mark zones that are heated through within each plot.**



Temperature measurements along the joint throughout the entire welding process are plotted as a heat map with isotherms in Figure 8. From this, it can be seen more clearly that it takes a longer time (120 s) to heat the edges of the panel, as opposed to the middle section (45 s). The entire welding process took 4.5 minutes, which is 30% faster than previous iterations of the welding process on this laminate and joint configuration, with preset rates. Once removed from the vacuum bag, the joint was manually loaded to try and induce failure, but the joint stayed intact, indicating a good joint was created.



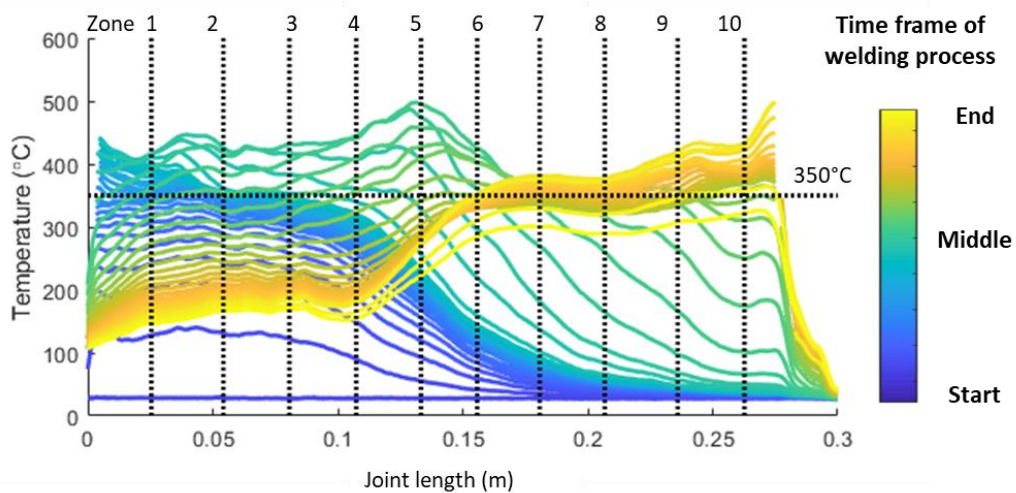
**Figure 8: Heat map of temperature along the joint throughout the entire welding process, using an unjacketed sensor.**

The unjacketed sensor was selected for embedding due to its small outer diameter. However, the resulting heat map above shows jagged isotherm profiles. It is suspected that when compressed under pressure within the joint, some amount of strain is coupling into the fiber sensor. This appears as a contribution to the temperature measurement. In order to physically decouple strain from temperature measurements, a PTFE-jacketed sensor was selected for embedding in the next test runs. Past experience had indicated that the PTFE jacket, while initially being a large inclusion within the joint during the setup stage, would ultimately be flattened in the joint due to the combination of temperature and pressure application throughout the process.

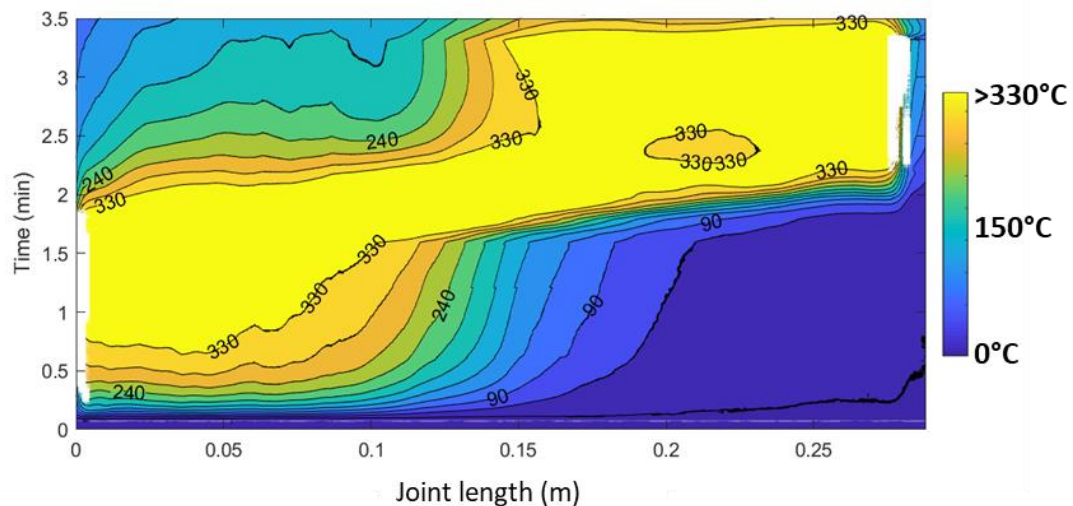
### 3.2 PTFE-Jacketed Sensor – Control Weld

A 710  $\mu\text{m}$  diameter PTFE-jacketed polyimide coated fiber optic sensor was laid within the shear joint. The additional PTFE tube does affect the time response of the fiber sensor, but the thermal time constant remains well below 1s, resulting in negligible impact over the time scale of the experiment. The current was set to 550 A, which is slightly higher than the previous test, in order to achieve a faster weld time. It can be seen from the spatial temperature profile along the joint (Figure 9) that once again it takes a longer time for sufficient heat to be generated at the edges of the panel, compared to the middle. Measurement traces are shown here at 0.8 s intervals.

Temperature measurements along the joint, throughout the entire welding process, are plotted as a heat map with isotherms in Figure 10. It is again clear that it takes a longer time to heat the edges of the panel (70 s), as opposed to the middle section (40 s). Both the spatial temperature profile of Figure 9 as well as the isotherms are much smoother as the fiber sensor is able to slide relative to the PTFE jacket when temperature changes. The entire welding process took 3.25 minutes, which is approaching 50% faster than previous iterations of the welding process, with preset rates. Once removed from the vacuum bag, the joint was manually loaded to try and induce failure, but the joint stayed intact, indicating a good joint was created. The presence of the initially large PTFE-tube inclusion did not affect the ability of the joint to be welded. This tube ended up being flattened within the joint and was no longer visible to the naked eye. In comparing this data set with the one obtained with the unjacketed sensor, it is obvious that the small amount of strain coupling to the temperature measurements is inconsequential, and the spatial temperature profile is effectively the same.



**Figure 9: Spatial temperature profile along the entire PTFE-jacketed sensor, with measurement traces shown at 0.8 s intervals.**

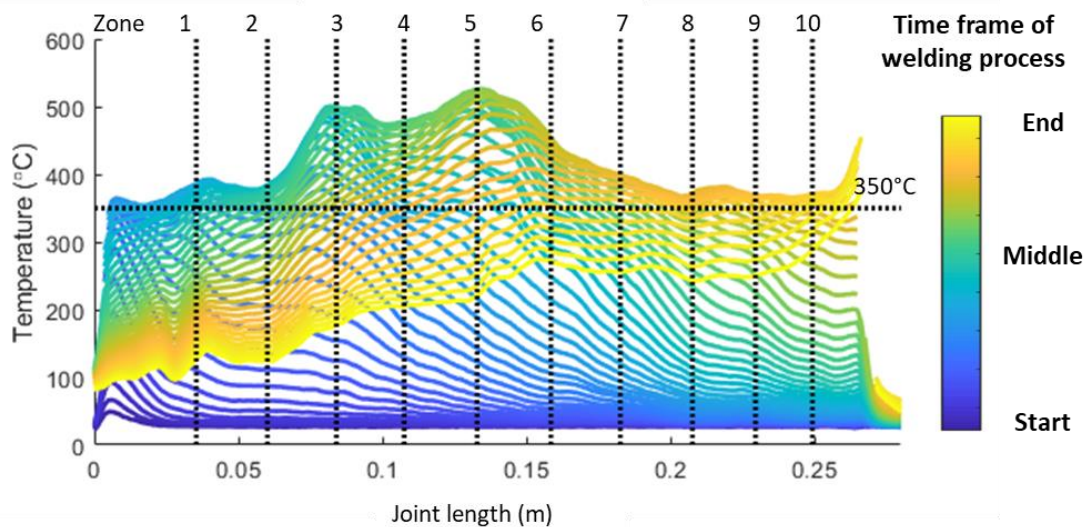


**Figure 10: Heat map of temperature along the joint throughout the entire welding process, using a PTFE-jacketed sensor.**

### 3.3 PTFE-Jacketed Sensor – Constant Travel Rate Weld

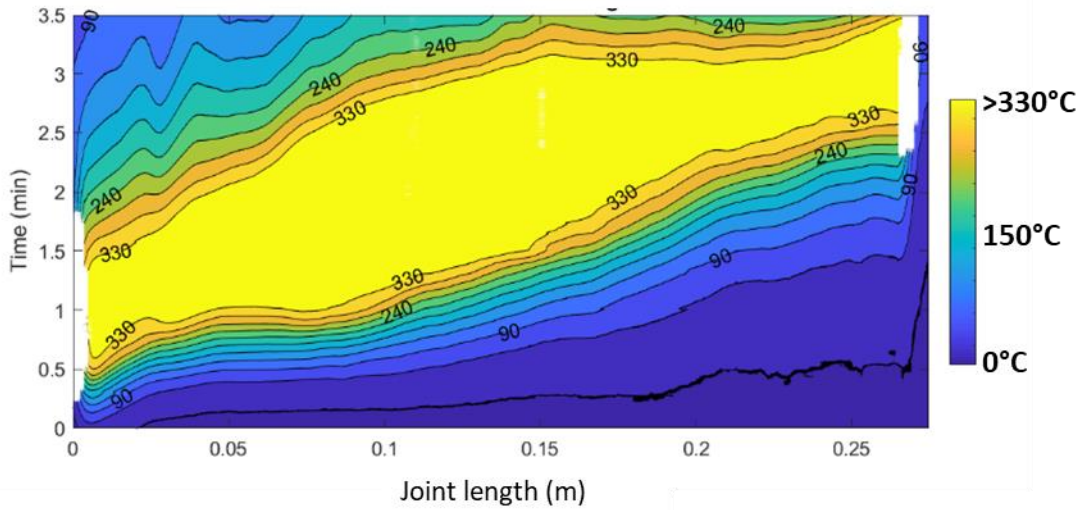
Within the induction welding industry, the preferred practice is to set up an induction weld process where the induction coil is traveling at a constant rate. This is largely due to the complexity of establishing spatially-based process parameters because of the prior limitation in the ability to make in-situ temperature measurements. In order to mimic this, the parameters of the successful controlled weld above were used to calculate a constant travel rate for this type of joint. Based on the known length of the joint (25.4 cm), and the process time achieved in the controlled-weld process (3.25 minutes), a constant travel rate of 1.27 mm/s was programmed for the induction coil.

A 710  $\mu\text{m}$  diameter polyimide coated fiber optic sensor was laid within the shear joint, and the current was set to 550 A. The spatial temperature profile along the joint for this process is shown in Figure 11, with measurement traces shown at 0.8 s intervals. A heat map with isotherms is shown in Figure 12. While the heat generated within the middle section of the panel reaches up to 500°C, the edges barely make it past 350°C. Not only does the middle section reach higher temperatures, but the middle stays at high temperatures for a much longer time than do the edges. With such high temperatures reached in the middle, there is a risk of material breakdown instead of successful welding. Additionally, such large temperature gradients might result in large residual strains that warp the final part.

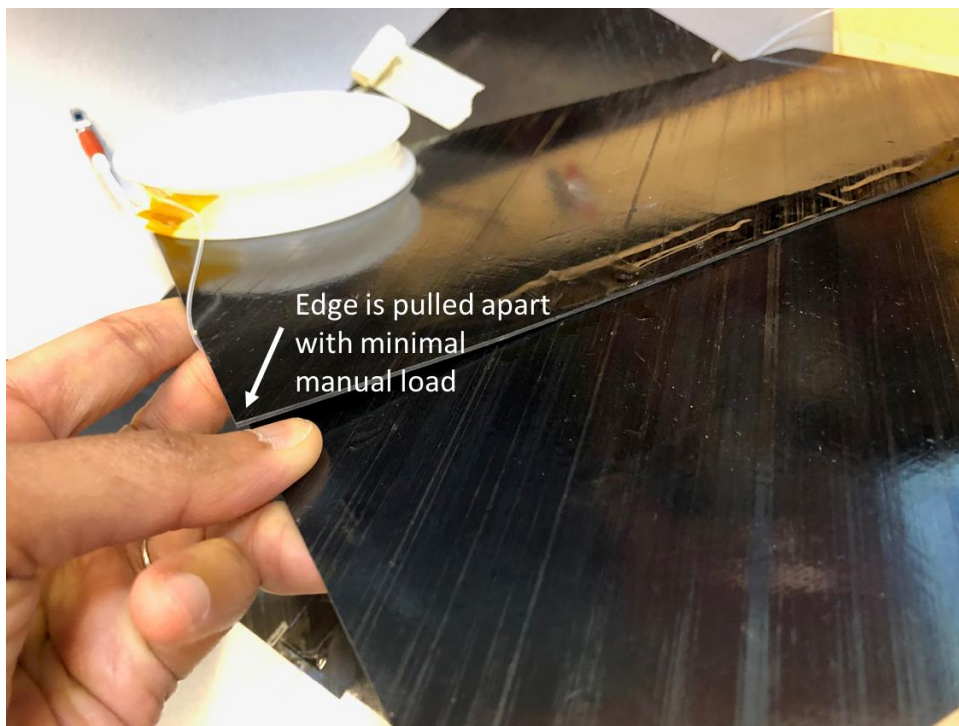


**Figure 11: Spatial temperature profile along the entire PTFE-jacketed sensor, with measurement traces shown at 0.8 s intervals, for a constant travel rate welding process.**

When removed from the vacuum bag and manually loaded, the edges are very easily peeled apart in zipper fashion, as shown in Figure 13. The middle section does however end up being very strongly welded together.



**Figure 12: Heat map of temperature along the joint throughout the entire welding process, using a PTFE-jacketed sensor, for a constant travel rate welding process.**



**Figure 13: Edge of panel processed with constant travel rate parameter is not fully welded**

#### **4. DISCUSSION**

The small form factor of the fiber sensor, coupled with its high spatial density, allows us to embed the sensor directly within the welded joint, and obtain in-situ temperature measurements along the length of the joint, throughout the entire welding process. This was previously not possible with traditional temperature measurement methods. The initial sensor configuration was

of a bare polyimide-coated fiber due to its small form factor. However, this resulted in strain coupling into the temperature measurements. Therefore, the next set of tests made use of PTFE-jacketed fiber sensors. By using the distributed fiber optic sensor to monitor the temperature profile and provide feedback to the welding operator, it was determined that there is a need to hold the welding coil longer at the edges compared to the middle of the panel. The heat maps from both sensors demonstrated this through the isotherms (Figure 8 and Figure 10). The 330°C isotherm as plotted shows that the time at temperature needed to be approximately twice as long at the edges as in the middle.

In contrast, when a fixed travel rate was set for the induction coil, taking into account the joint length and time taken with the feedback-control process, the resulting weld was not as strong at the edges. The time spent at temperature ended up being half as long at the edges as in the middle, resulting in a poor weld. Additionally, with a fixed travel rate, the middle of the panel became very hot, approaching temperatures that could lead to material degradation. These differences are also represented in the time trace plots shown in Figure 14.

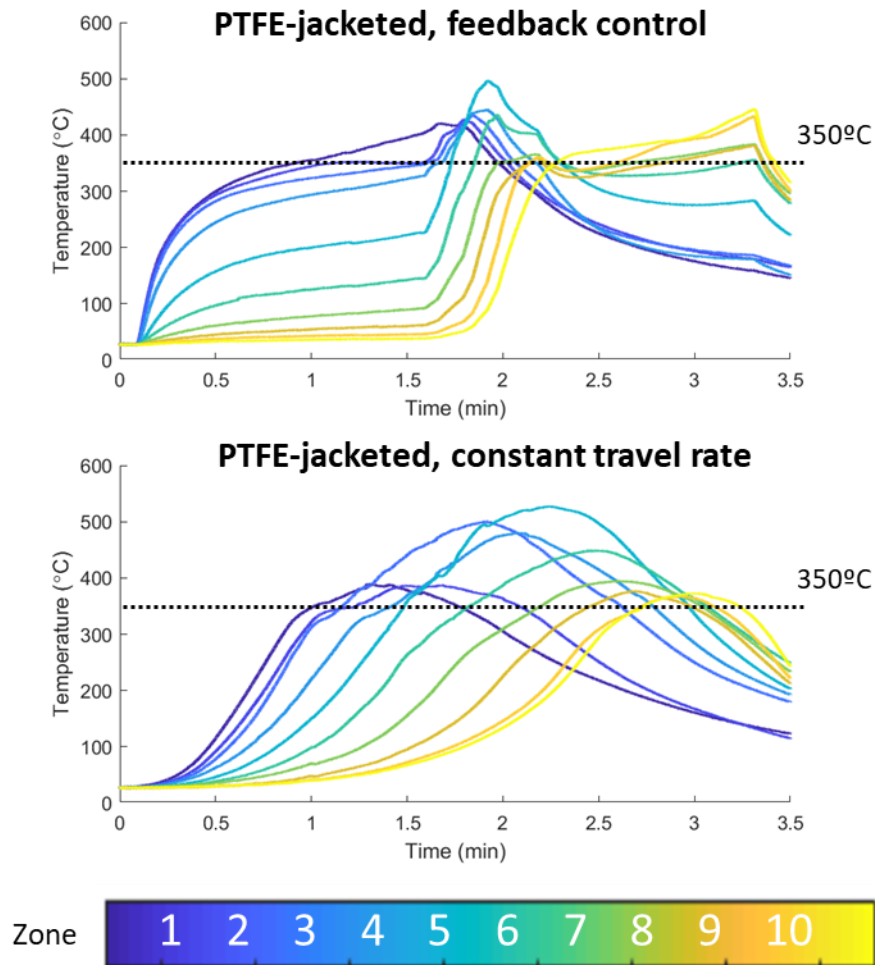


Figure 14: Time trace plot for each of the zones, throughout the welding process.

## 5. CONCLUSIONS

The work reported here showcases the use of the embedded distributed temperature measurement system for in-situ, real-time monitoring of temperature within the weld zone and live feedback to the weld operator for immediate process parameter modification (in this case, induction coil location). This is very useful for experimentally quantifying process parameters in a production environment. Traditionally, process parameters are quantified by post-processing real-time temperature data to zoom in to the optimal process parameters. Measurement methods are limited to either discrete sensors that are too large and too unwieldy to embed continuously along an entire joint (e.g. thermocouples), or to camera-based methods that constraints the user to measuring external surface temperatures (e.g. IR cameras). This results in a lengthy and expensive process, largely due to the indirect costs associated with wasted material from repeat testing and system usage for parameter development and certification. With the feedback control loop implemented, the processing time for this specific weld configuration was reduced by ~50% from the typical constant travel rate setup, while still achieving a solid welded joint, with just a small set of tests. At the very least, this technology enables a non-linear control profile to be determined for parts in which leaving the sensor in place is not viable.

The next steps for this work will be to close the control loop and eliminate the operator. This will result in continuous feedback from the embedded sensor back to the integrated induction welding system for process parameter optimization, namely controlling either the current set point or coil position and speed along the weld zone. It would also be useful to section the joint to analyze its dimensional integrity. Additionally, mechanical testing of the joint fixed in a load frame will provide an objective experimental validation of the strength of the joint.

## 6. REFERENCES

1. Yousefpour, A., Hojjati, M., & Immarigeon, J. P. "Fusion bonding/welding of thermoplastic composites." *Journal of Thermoplastic composite materials* 17(4) (2004): 303-341.
2. Costa, A. P. D., Botelho, E. C., Costa, M. L., Narita, N. E., & Tarpani, J. R. (2012). A review of welding technologies for thermoplastic composites in aerospace applications. *Journal of Aerospace Technology and Management*, 4(3), 255-265.
3. Velthuis, R. "Induction Welding Technology-Joining Fiber Reinforced Thermoplastic Polymer (composites) for Aerospace Applications." In *54th International Astronautical Congress of the International Astronautical Federation, the International Academy of Astronautics, and the International Institute of Space Law* (2003): I-3.
4. Rudolf, R., Mitschang, P., & Neitzel, M. "Induction heating of continuous carbon-fibre-reinforced thermoplastics." *Composites Part A: Applied Science and Manufacturing* 31(11) (2000): 1191-1202.
5. Stokes, V. K. "Experiments on the induction welding of thermoplastics." *Polymer Engineering & Science* 43(9) (2003): 1523-1541.
6. Abdul Rahim, N. A., Davis, M. A., Routhier, L., Chang, B., Chevalier, J., Bos, J. J., Kreger, S. T., & Sanborn, E. E. "Accuracy and Survivability of Distributed Fiber Optic Temperature Sensors." *53rd AIAA Aerospace Sciences Meeting, AIAA SciTech Forum* (2015)

7. Abdul Rahim, N. A., Metrey, D., Huang, J., and Davis, M. A. "Measuring Uniformity of Cure Temperatures Using High-Definition Fiber Optic Sensing." *CAMX Conference Proceedings*. Dallas, TX, October 15-18, 2017. *CAMX – The Composites and Advanced Materials Expo*
8. Pandher, J., van Tooren, M., Davis, M., & Fant, J. "In-Process Monitoring of Induction Welding of Thermoplastic Composites Based on Fiber Optics." *Society of Plastic Engineers (SPE)/Automotive Composites Conference & Exhibition (ACCE)*, 2018
9. Froggatt, Mark, and Moore, Jason. "High resolution strain measurement in optical fiber with Rayleigh scatter." *Appl. Opt.* 37 (1998): 1735-1740.
10. Kreger, S., Gifford, D. K., Froggatt, M. E., Soller, B. J., and Wolfe, M. S. "High resolution distributed strain or temperature measurements in single- and multi-mode fiber using swept-wavelength interferometry." *Optical Fiber Sensors, OSA Technical Digest*. Cancun, Mexico, October 23, 2006. Optical Society of America, 2006. Paper ThE42. CD-ROM.
11. TenCate TC1320, Product Data Sheet (TenCate Advanced Composites, Morgan Hill, CA, USA). July 2018.